



HIGH VOLUME
LOW SPEED FANS

APPLICATION

The THS range of High Volume Low Speed fans are designed to be installed in high ceilings to redistribute air towards floor level.

They generate a gentle and slowly moving airstream which covers a large area and create a cooling effect in summer while they de-stratify the air in winter pushing the warm air down at floor level.

They are suitable for commercial, industrial and agricultural applications such as warehouses, manufacturing facilities, industry, shopping malls, airports, sports centres, greenhouses, dairy farms.

CONSTRUCTION

- Upper frame made of painted steel welded structure to protect the motor.
- Safety cables and 800mm length downrod provided as standard.
- Specially designed airfoil made from aluminium EN AW 6063 T6. The surface is anodized to avoid corrosion.
- Aerodynamically shaped blade tips made in plastic.
- Hub provided with safety ring.
- Aesthetic hub cover made in plastic.
- High efficiency three-phase EC brushless motor, which are specifically designed for HVLS application, 200-480Vac/3ph/50/60Hz, IP65, with integrated electronic system and EMC filters. Suitable for S1 continuous service. Speed controllable.

FEATURES & BENEFITS

- "Wide cone" air distribution under the fan.
- Top silent operation thanks to the gearless motor and the special airfoil design.
- Ideal to integrate the HVAC system, for energy saving and CO2 emission reduction.
- In winter months they are suitable to de-stratify the air pushing the warm air towards the floor level, so to even the temperature and to prevent the HVAC system to run as hard.
- In summer time the constant and gentle breeze eliminates hot and cool spots in the building by improving the internal environment and creating a natural cooling effect. The air movement also helps keeping the insects away.
- No ordinary maintenance.
- Robust steel structure for long life.
- Key safety features (main security wire, additional stabilising cables, hub safety ring).
- Blade tips to optimise performances and acoustic comfort.
- Hub cover to protect the motor from dust and for a better aesthetics.
- Simplified electrical connection: pre-cabled.
- Integrated EMC filters to prevent electromagnetic interference from other devices.
- Fan are suitable for operating temperatures from 0°C to +50°C.
- Unit performances are tested to the latest AMCA standard meaning accurate information that can be relied upon.

- Designed and manufactured in accordance with Machinery Directive (MD), Low Voltage Directive (LVD), Electromagnetic Compatibility Directive (EMC).

ACCESSORIES

- Different length downrod
- Remote controllers
- I-Beam fixing kit
- Glulam fixing kit

Performance @ 400Vac 50Hz

Description	No. Blades	Max Rotation Speed	Max Absorbed Power	Max Thrust	Max Air Flow AMCA 230-15			Max Air Flow AMCA 230-99			Affected diameter ⁽²⁾
					cfm	m ³ /h	SPI ⁽¹⁾ W/(m ³ /s)	cfm	m ³ /h	SPI ⁽¹⁾ W/(m ³ /s)	
THS400	5	110	1,03	188	95191	161730	22,9	134620	228721	16,2	35
THS500	5	80	1,07	208	124849	212119	18,2	176563	299982	12,8	42
THS600	5	60	0,9	246	162662	276363	11,7	230038	390836	8,3	62
THS730	5	51	1,2	334	228696	388555	11,1	323425	549500	7,9	73

(1) Max absorbed power / max airflow

(2) min. average air speed 0,8 m/s with testing layout in conformity with AmCA 230

Dimensions

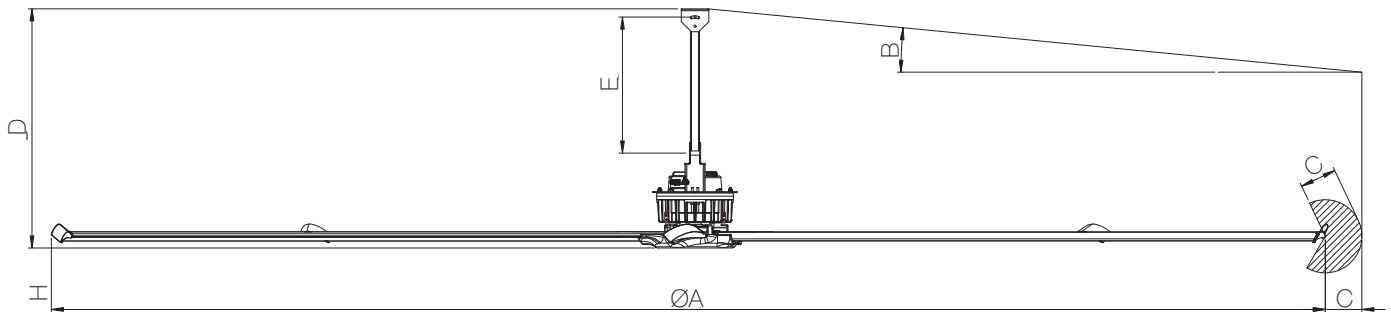

Description	ØA	B max ceiling slope	C min safety distance from side obstruction	D fan height with standard downrod	E standard downrod length	H min fan installation height	Weight
	mm	°	mm	mm	mm	mm	kg
THS400	4050	20	450	1270	800	2700	91
THS500	5050		550	1270			101
THS600	6050		650	1304			118
THS730	7300		750	1304			130

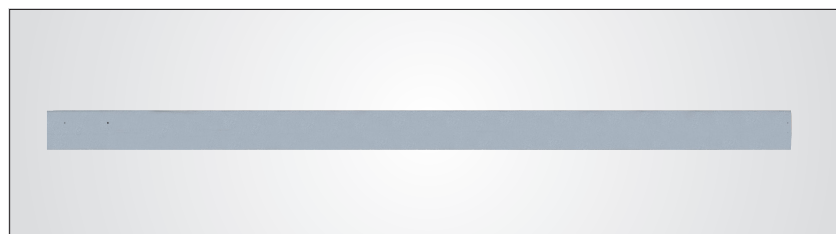

Straight blade profile



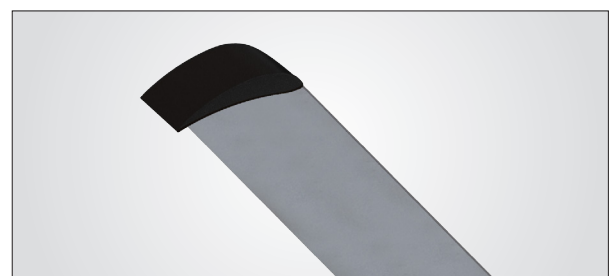

Aesthetic hub cover



45° aerodynamic blade tip

Accessories

Description	 CTRL-HS	 CTRL-A	 Downrod	I-Beam	Glulam					
	Description	Code	Description	Code	Description	Code	Description	Code	Description	Code
THS400	CTRL-HS	004154	CTRL-A	002049	TUB300	002220	KT-I-BEAM	003357	KT-GLULAM	004009
THS500					TUB1500	000817				
THS600					TUB3000	003757				
THS730										

CTRL-HS



- 3,5" TFT full touch-screen colour graphic display control panel
- Provides a single point of control for up to 4 units
- RS-485 ModBus connection

CTRL-A



- Potentiometer with front knob to adjust the motor speed
- Provided with two-pole switch (ON/OFF)
- Front yellow led to indicate that the load is active
- Controls one fan only
- 230V~ 50/60Hz
- Supplied with IP55 wall surface box

Downrod

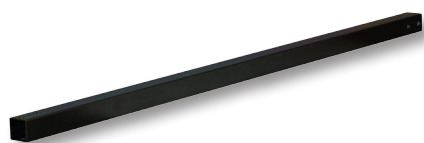

- Downrod made from painted steel
- Different length downrod on request

Description	Weight (kg)	Dimensions (mm)
TUB300	1,3	50x50x3 - L=300
TUB1500	6,6	50x50x3 - L=1500
TUB3000	13,2	50x50x4 - L=3000

I-Beam

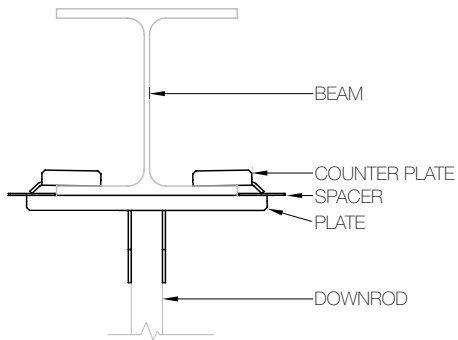

- I-Beam fixing kit suitable for standard IPE, HEA and HEB100 profiles
- Fixing screws supplied

Model	Range
IPE	from IPE180 to IPE600
HEA	from HEA100 to HEA400
HEB	from HEB to HEB300

Glulam

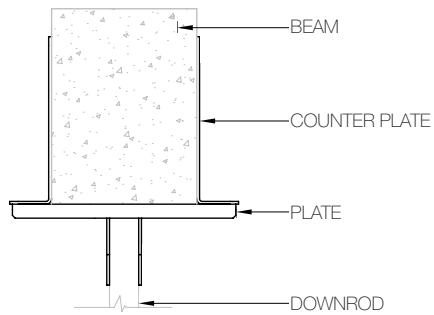

- Fixing kit suitable for rectangular beams with base between 100mm and 260mm
- Fixing screws supplied